

HEUERNTE

HAY-HARVEST
RÉCOLTE DES FOINS
HOOIEN



Art. Nr. 180561

D

Vor Beginn des Bastelns sollten Sie sich mit den Spritzlingen und der Anleitung vertraut machen. Sollte es einmal vorkommen, dass ein Teil im Bausatz fehlt, kreuzen Sie bitte das fehlende Teil in der Anleitung an und schicken Sie diese bitte an Fa. Gebr. FALLER GmbH, Abt. Kundendienst, kundendienst@faller.de, Kreuzstraße 9, 78148 Gütenbach. Sie erhalten dann umgehend Ersatz. In diesem Bausatz sind einige Kunststoffteile übrig.

GB

Before beginning with the assembly please familiarize yourself with the parts and read the instructions carefully. In case of missing parts please indicate these on the instructions leaflet with a circle and return the leaflet to Gebr. FALLER GmbH, kundendienst@faller.de, Kreuzstraße 9, D-78148 Gütenbach, Germany. You will receive the replacement by return. Some of the parts in this box are not needed to construct the model.

F

Avant de commencer le montage de votre maquette bien lire la notice et repérer les grappes. Si une pièce manque dans une boîte, cochez la pièce correspondante sur la notice et renvoyez-la-nous à Gebr. FALLER GmbH, kundendienst@faller.de, Kreuzstraße 9, D-78148 Gütenbach (R.F.A.). Nous vous ferons parvenir la pièce par retour. Dans cette boîte se trouvent quelques pièces qui ne seront pas utilisées pour le montage.

NL

Vóór het bouwen zou men de gielstukken en de handleiding moeten bestuderen. Indien onverhoopt een onderdeel aan het bouwpakket ontbreekt, gelieve men het ontbrekende deel in de handleiding aan te kruisen en deze te zenden aan Gebr. FALLER GmbH, kundendienst@faller.de, Kreuzstraße 9, D-78148 Gütenbach. U ontvangt dan omgaaend en gratis het ontbrekende onderdeel. Van dit bouwpakket worden enkele kunststof delen niet gebruikt.

Für den Zusammenbau des Modells empfehlen wir folgende FALLER-Artikel (sind nicht im Bausatz enthalten):
For the assembly of the kit we recommend following FALLER products (not included in the kit):
Pour l'assemblage du modèle, nous vous recommandons les articles FALLER suivants (non inclus dans le kit):
Om dit model te bouwen adviseren wij de volgende FALLER producten (maken geen deel uit van deze bouwset):



Art. Nr. 170492
FALLER-EXPERT

Flüssigkleber in Plastikflasche mit Spezialkanüle für feinste Klebstoffdosierung.

Liquid cement in plastic bottle with canule for very fine dosage.

Colle liquide en bouteille plastique avec bec verseur pour un dosage précis.

Vloeibare lijm in plastic-flescon met doseerbuisje om nauwkeurig te lijmen.



Art. Nr. 170688
SPEZIAL-SEITENSCHNEIDER

zum gratfreien Abtrennen von feinsten Spritzteilen.
Nur für Polystyrol geeignet.

Special side cutter for cutting off ultra-fine moulded parts without burrs.
Only suitable for polystyrene.

Pince coupante spéciale pour couper sans bavure les pièces miniatures moulées par injection. Convient uniquement au polystyrène.

Speciale zijknijptang voor het boraamloos afknippen van de fijnste gielstukdelen. Alleen geschikt voor polystyrol.

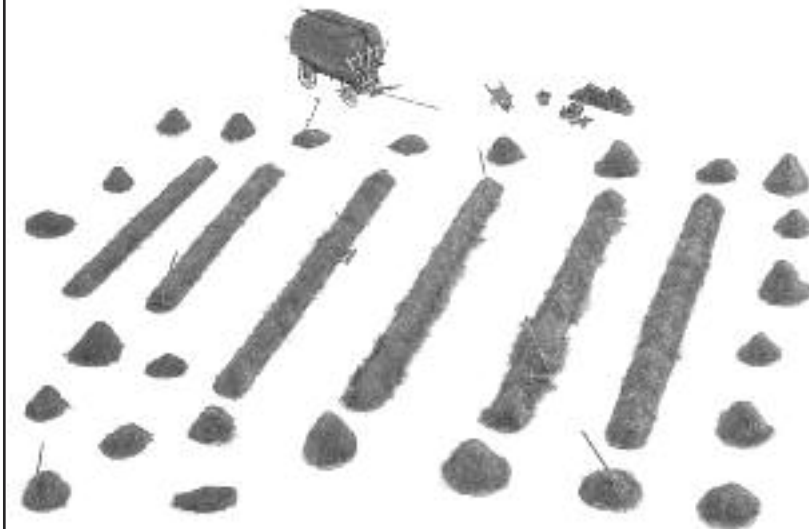

Sa. Nr. 230 952 0

2

43/9 — nicht kleben
do not glue
ne pas coller
niet lijmen



(A)

43/1

43/6 — nicht kleben
do not glue
ne pas coller
niet lijmen



(B)

(A)

43/8

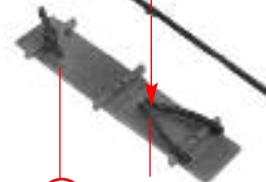

(C)

(B)

43/3

43/5

43/2

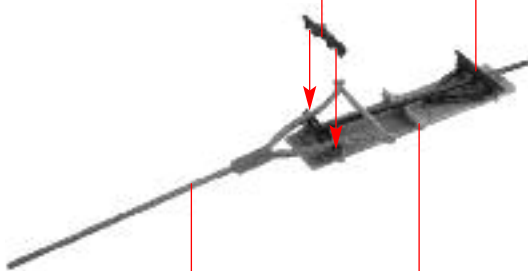

(D)

43/11

(C)

43/4

43/7

43/10

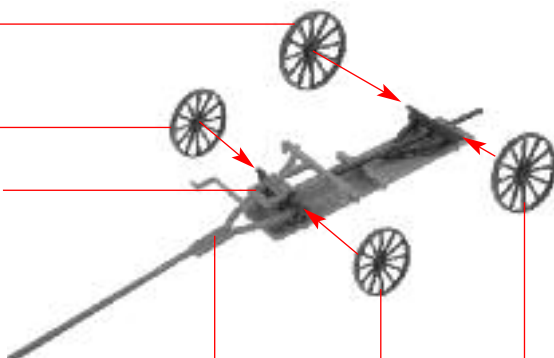

(E)

(D)

43/7

43/4

43/12

43/13

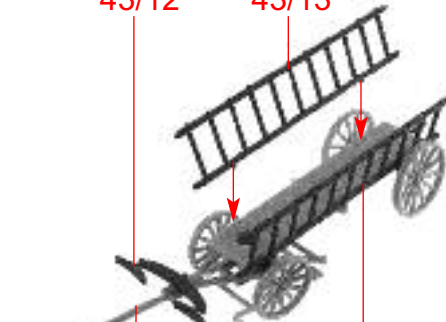

(F)

(E)

43/13

43/16

43/16

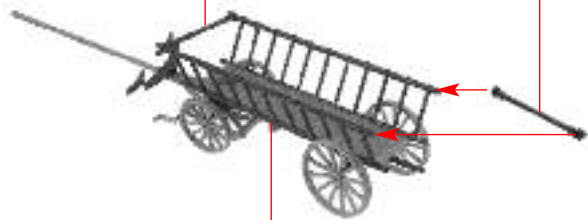

(G)

(F)

43/17

43/17

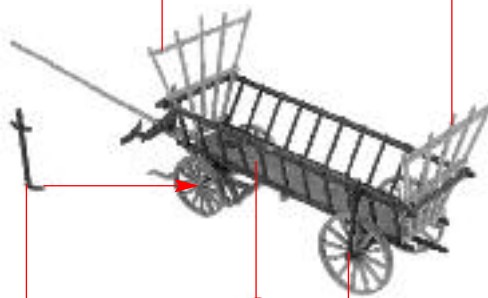

(H)

43/15

(G)

43/14

(I)

(H)

43/14

43/15

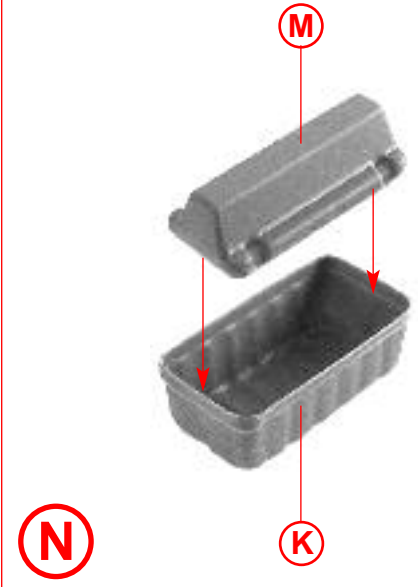
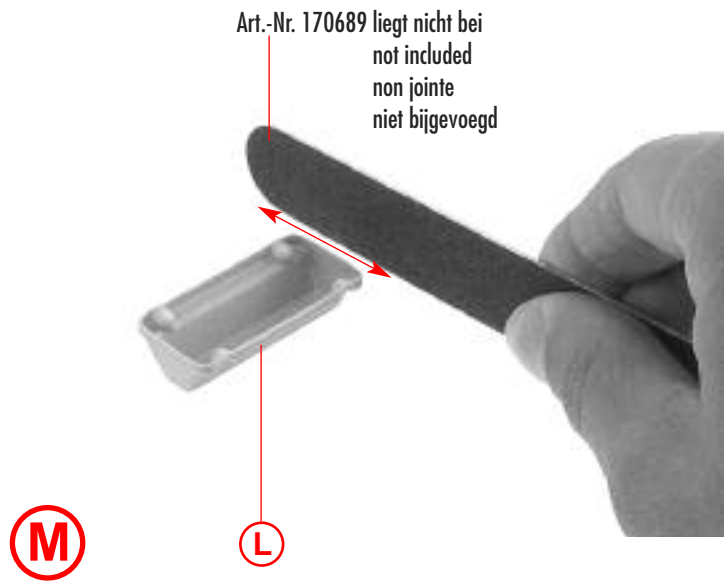
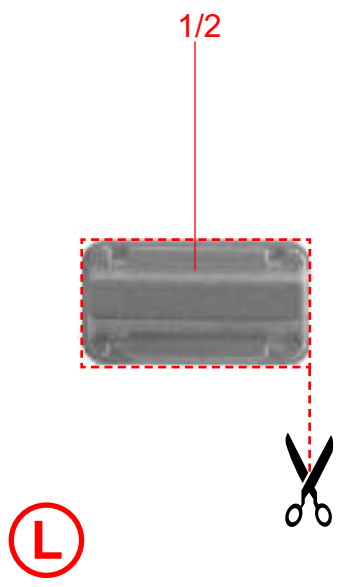
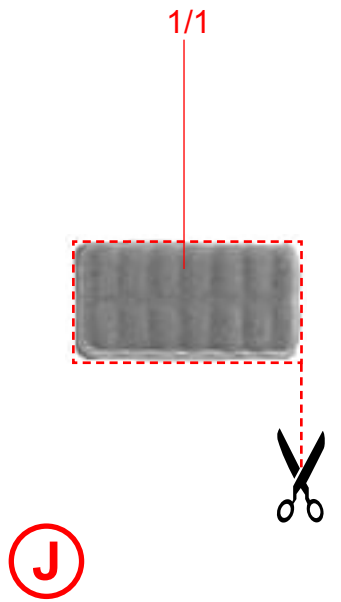
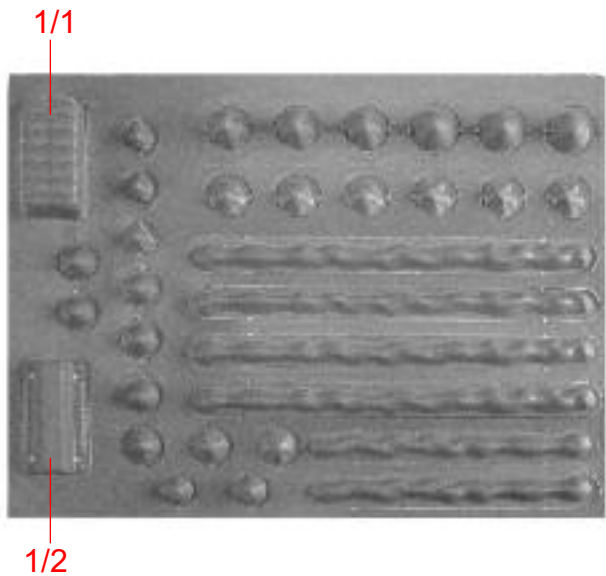

N



P



O



Q

Inhalt	Tüte	Contents bag
Contenu	sachet	Inhoud zakje

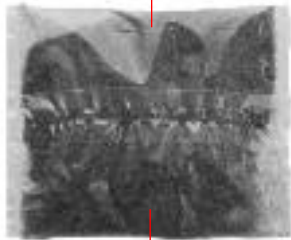

Inhalt	Tüte	Contents bag
Contenu	sachet	Inhoud zakje

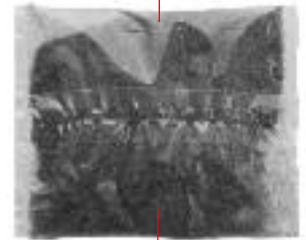

Holz- und Bastelleim

Weißer Holzleim (mit Wasser verdünnbar) für viele Zwecke des Modellbaus und zum Auftragen von Streumaterial auf Anlagen.
Der Leim ist nach dem Trocknen glasklar. Nicht kühl lagern.

Wood cement

A whitewood cement (may be diluted with water).
Especially suitable for gluing scenery material. Dries transparent. Do not store cool.

Colle pour bois et bricolage

Colle blanche (peut-être allongée à l'eau). Limpide après séchage, convient pour fixer le flocage. Ne pas entreposer au froid.

Hout-en hobbylijm

Witte houtlijm (kan met water verdund worden) voor vele doeleinden in de modelbouw en voor het aanbrengen van strooimateriaal.
Na het drogen is de lijm doorzichtig. Niet koel opbergen.

P

O

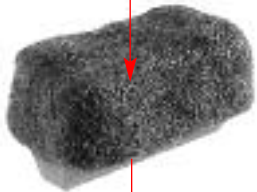

R

Q



43/18

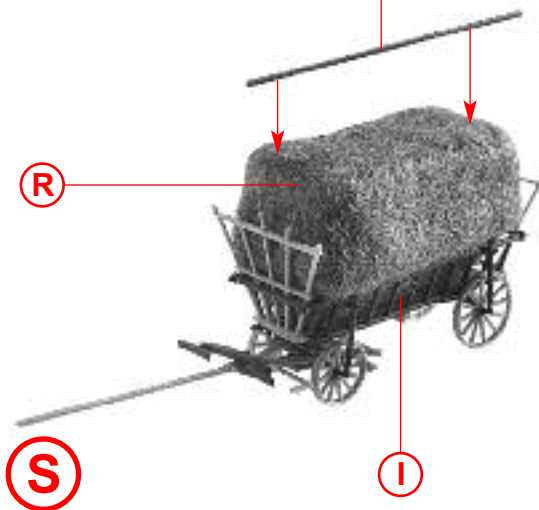

Fadenverlauf, ca. 10 cm
Course of thread
Trajet du fil
Het verloop van de draden

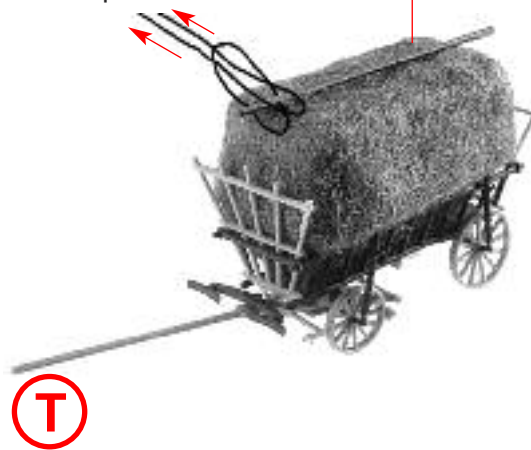

Faden verknoten und den Knoten
mit Sekundenkleber fixieren !

Knot the thread and fix the thread
with instand cement !

Nouer le fil et renforcer le noeud
avec une goutte de colle rapide !

Draad vastknopen en de knoop
met secondenlijm fixeren !

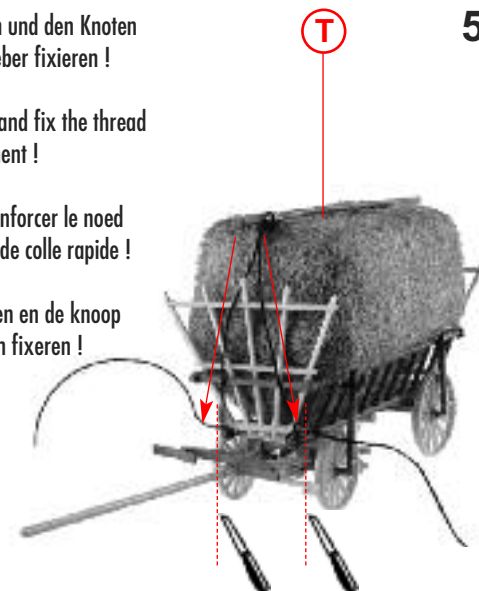

Fadenverlauf, ca. 10 cm
Course of thread
Trajet du fil
Het verloop van de draden

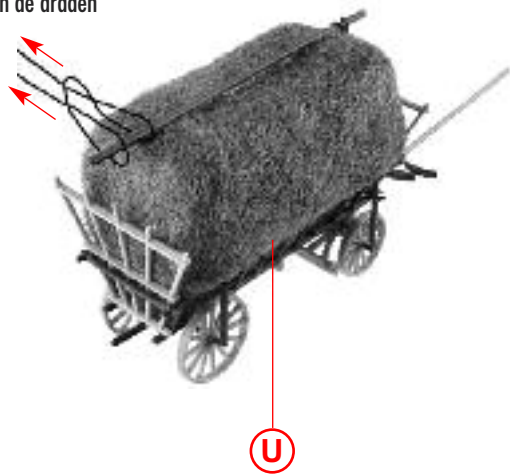

Faden verknoten und den Knoten
mit Sekundenkleber fixieren !

Knot the thread and fix the thread
with instand cement !

Nouer le fil et renforcer le noeud
avec une goutte de colle rapide !

Draad vastknopen en de knoop
met secondenlijm fixeren !

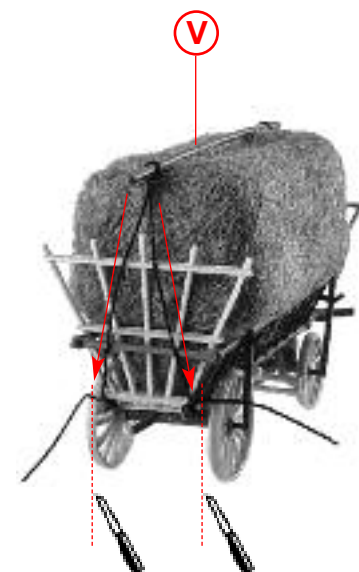

6

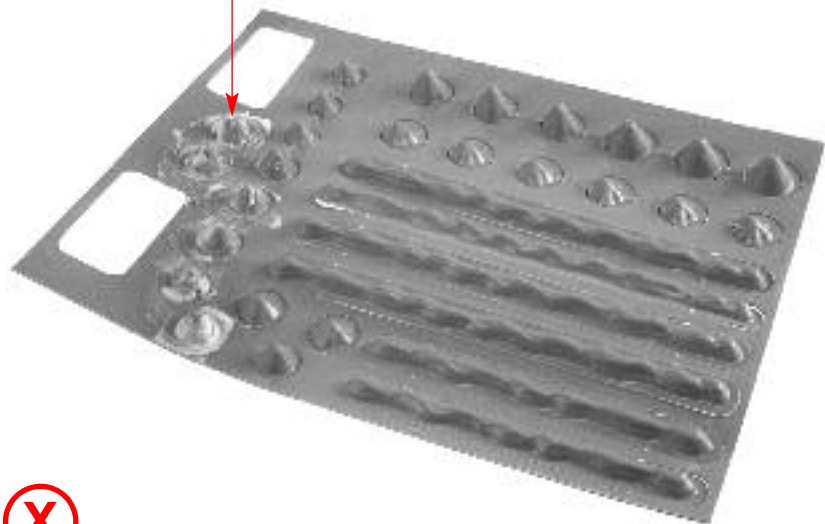

X

Inhalt	Tüte	Contents	bag
Contenu	sachet	Inhoud	zakje

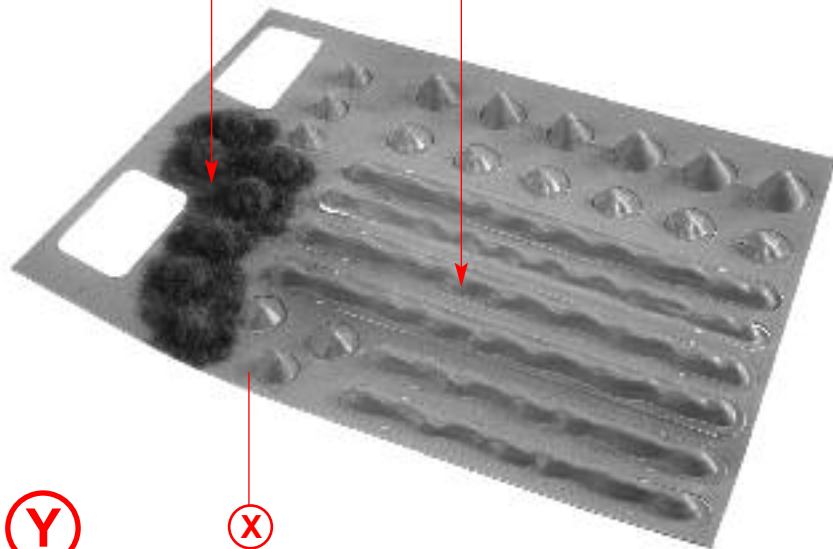
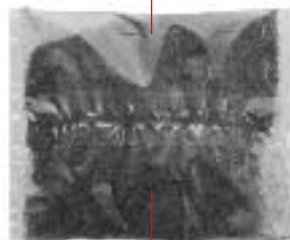

Y

X

Inhalt	Tüte	Contents	bag
Contenu	sachet	Inhoud	zakje



ausschneiden
cut out
découper
uitsnijden

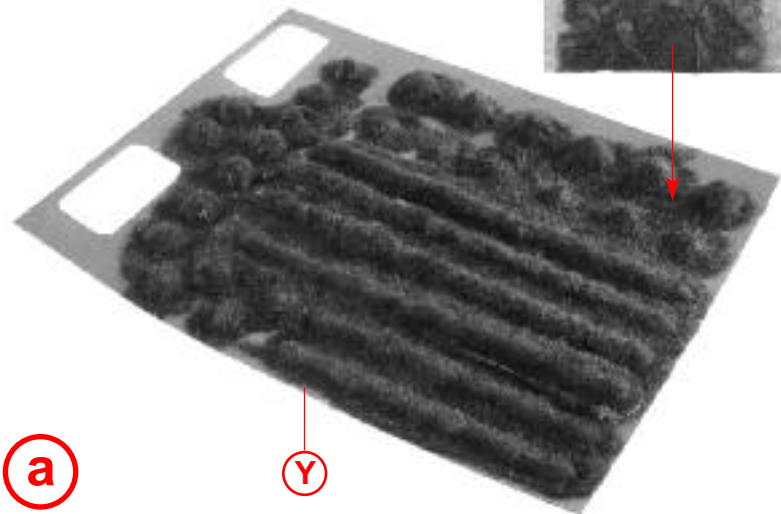

a

Y

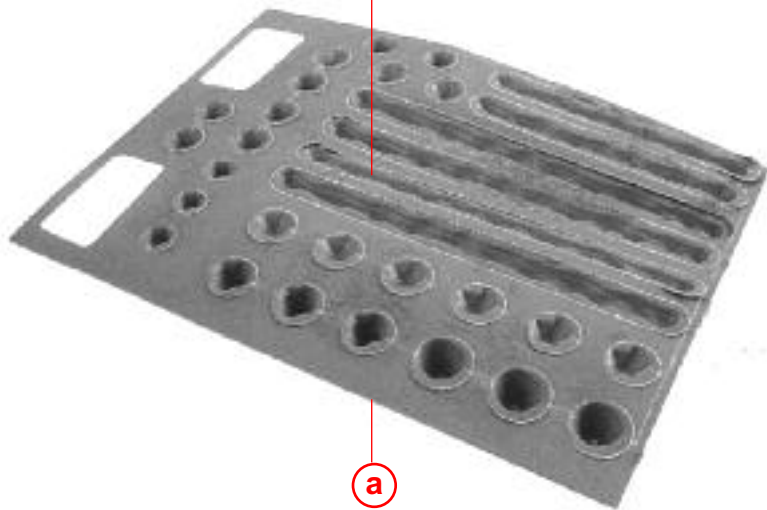

b

a

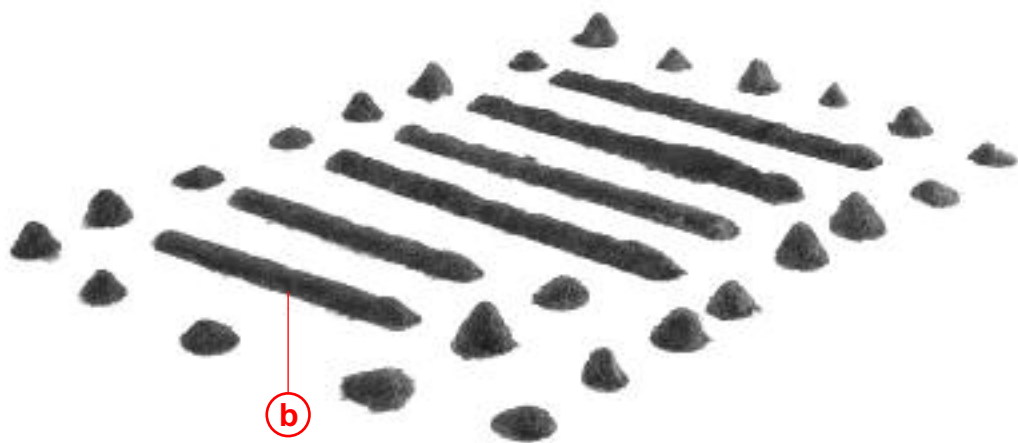

c

b

8

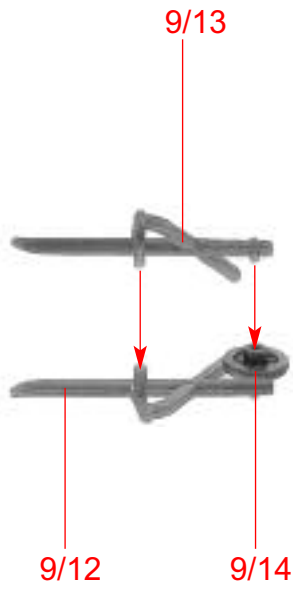

d

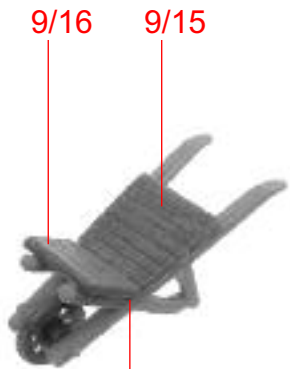

e

d

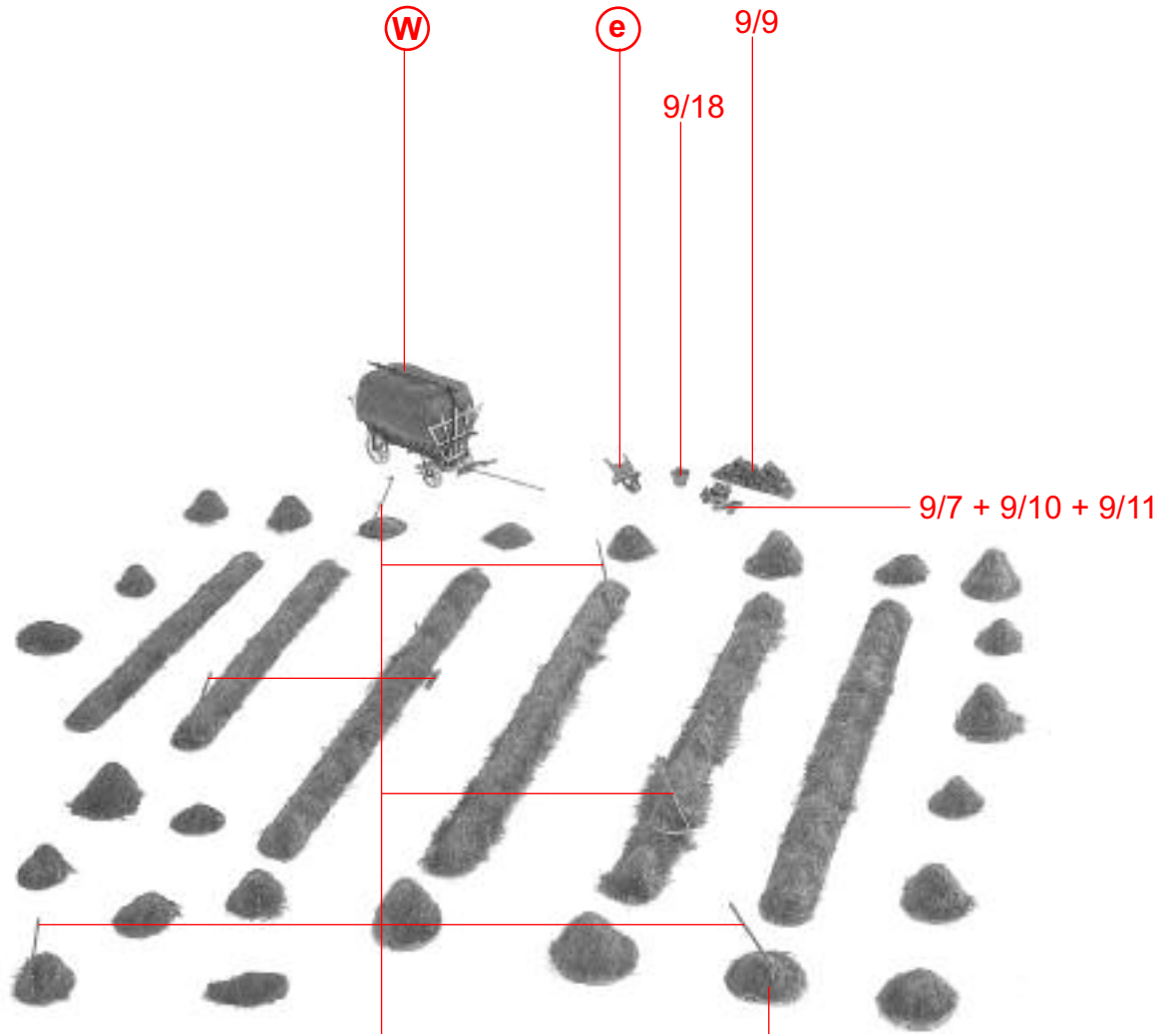

f